



FRANKONIA

- ANECHOIC CHAMBERS & SHIELDED ROOMS
- ACCESSORIES FOR ANECHOIC CHAMBERS / SHIELDED ROOMS
- RADIATED IMMUNITY TEST SYSTEMS
- RF-POWER-AMPLIFIERS
- **BROADBAND ANTENNAS**
- EMC TEST & MEASUREMENT INSTRUMENTS
- GTEM-CELLS



## ANTENNAS ANTENNA MASTS PRE-AMPLIFIER



# THE FRANKONIA GROUP



## Frankonia Group

The FRANKONIA GROUP was founded in 1987 as a solution provider for EMC laboratories to meet the increasing demand for highly specialized testing environments for the electronic and automotive industry. With more than 25 years of experience to date, FRANKONIA maintains its leading position in EMC solutions worldwide. Without limitations in capabilities and resources, FRANKONIA develops future-oriented concepts for EMC laboratories, which guarantees an optimal use of resources as well as the best possible customized solutions.

- FRANKONIA demonstrates a global presence in cooperation, with a well-structured network of productions, representations and service units.
- FRANKONIA strives to be the preferred partner for customized and state-of-the-art solutions.
- FRANKONIA provides fundamental knowledge to operate as a complete solution provider.
- FRANKONIA implements innovative technologies to enhance the efficiency and improve the outcomes and quality along with customers' needs.



We are proud of our highly specialized team that is putting our customers' demands into practice. It is our philosophy to improve the products, to realize new ideas, and to complete our product range within our broad scope of business. The fact that FRANKONIA is able to offer complete solutions from the first sketch to the final handover makes FRANKONIA a unique and trustworthy partner worldwide.

## Frankonia's authenticity

FRANKONIA stands for latest technologies, highest quality, innovative concepts and materials and reliable solutions. Due to its easy and efficient usability along with its time-saving configuration, Frankonia's Anechoic Chambers set new standards for innovative and complete EMC testing solutions and offer a real added value to our customers.

## Frankonia solutions

FRANKONIA as a turnkey solution provider and manufacturer offers a complete range of anechoic chambers and RF-shielded enclosures, test equipment, instruments, software and accessories.



- 1 FRANKONIA GmbH
- 2 Frankonia EMC Test-Systems GmbH
- 3 FRANKONIA - POLAND Sp. z o.o.
- 4 FRANKONIA Huize Co., Ltd.
- 5 Jiashan FRANKONIA EMC Co., Ltd.



ANTENNAS	PAGE
ALX-4000 / ALX-4000E / ALX-8000E	4-5
AXL-80	6
AXL-80-S	7
AXL-80-ES	8
AXL-80-6G	9
AXL-200	10
MAX-9	11
MAX-18	12
HAX-6	13
HAX-6-KFZ	14
HAX-18	15
HAX-40	16
SAX-10	17
LAX-10	18
SAM-6	19
SAM-18	20
BROADBAND PRE-AMPLIFIER	21
FPA-18	22
FPA-26	23
FPA-40	24
FPD-01	25
FSM-1.6 / FSM-2.0 / FSM-4.0	26
FAM, FBM 1-4	27

# BROADBAND ANTENNA ALX-4000 / ALX-4000E / ALX-8000E

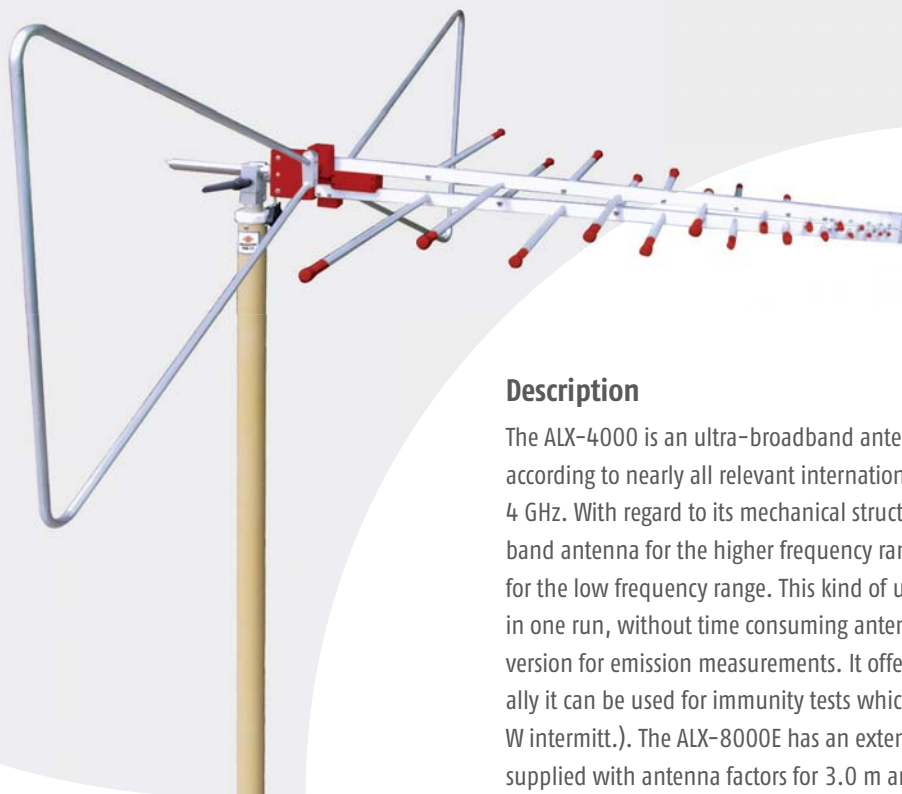

## Description

The ALX-4000 is an ultra-broadband antenna for emission measurements and immunity tests according to nearly all relevant international standards in the frequency range from 25 MHz up to 4 GHz. With regard to its mechanical structure it is a linear polarized logarithmic periodic broadband antenna for the higher frequency range, combined with a 4:1 broadband dipole (aluminum) for the low frequency range. This kind of ultra-broadband antenna allows performance of EMC test in one run, without time consuming antenna changes. The ALX-4000E is an especially optimized version for emission measurements. It offers lower antenna factors and improved VSWR. Additionally it can be used for immunity tests which require an input power of less than 100 W cw (200 W intermitt.). The ALX-8000E has an extended frequency range up to 8 GHz. All antennas are supplied with antenna factors for 3.0 m and 10.0 m measuring distance (1.0 m on request).

Technical specifications	ALX-4000	ALX-4000E	ALX-8000E
Frequency range	25 MHz to 4 GHz		25 MHz to 8 GHz
Max. input power	100 MHz - 900 W 500 MHz - 300 W 1000 MHz - 210 W 2000 MHz - 140 W 3000 MHz - 100 W		200 W (intermitt.) 100 W (cont.)
Nominal impedance	50 Ω		
Connector	type N female		
Isotropic gain (LP-Section)	6.4 +/- 1.2 dBi		
Antenna factor	4 ... 37 dB/m	7 ... 34 dB/m	7 ... 43 dB/m
Standing wave ratio SWR typ.	< 1.5		<1.5 (f > 150MHz)
Front to back ratio	20 dB (f > 150 MHz)		
Cross polarization	>20 dB (30 MHz...1 GHz)		
3 dB beamwidth typ. (E-Plane)	45°-65° (f > 150 MHz) ≈ 78° (f < 150 MHz)		
3 dB beamwidth typ. (H-Plane)	90°-120° (f > 150 MHz)		
Dimensions (W x L x D)	1500 x 910 (1240) x 620 mm		1500 x 920 (1253) x 620 mm
Weight	3.1 kg		
Fixation (indexing ring)	22 mm tube		
Use	Emission measurements Radiated immunity tests		

ALX-4000

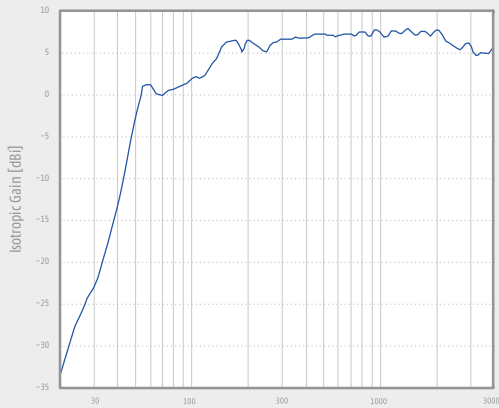

ALX-4000E

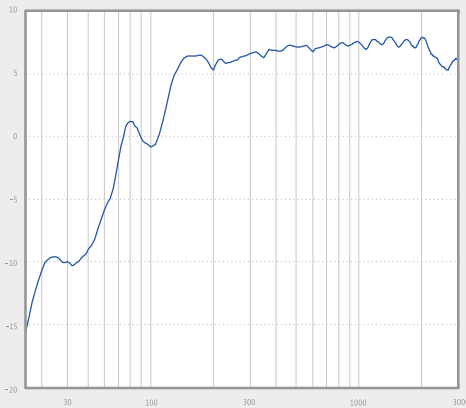

ALX-8000E

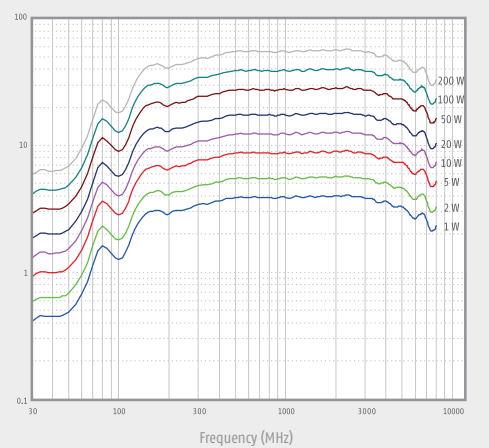
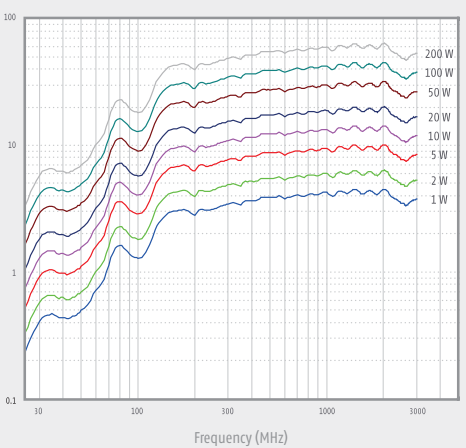
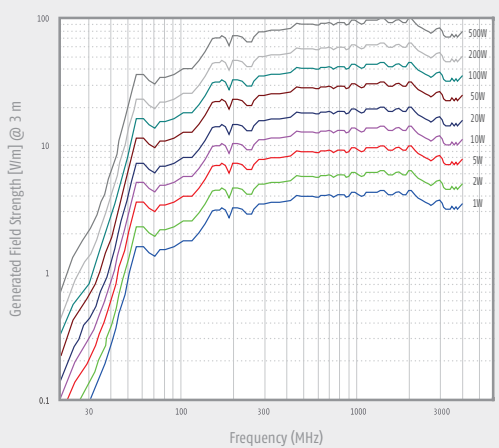
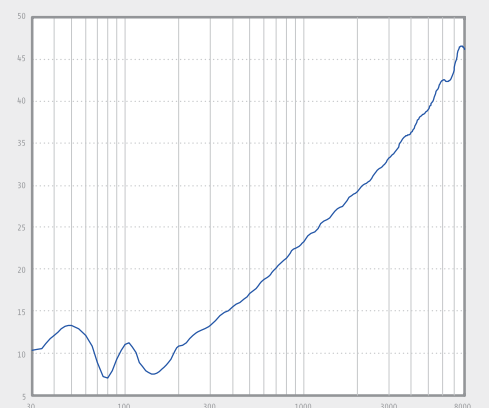
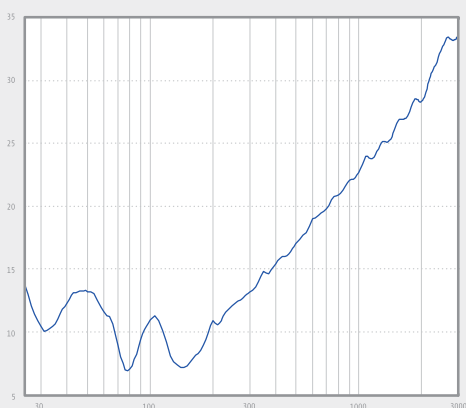
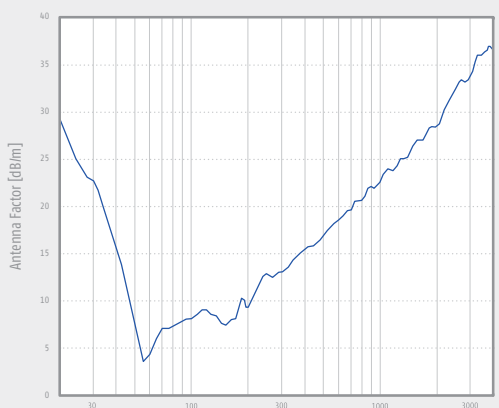
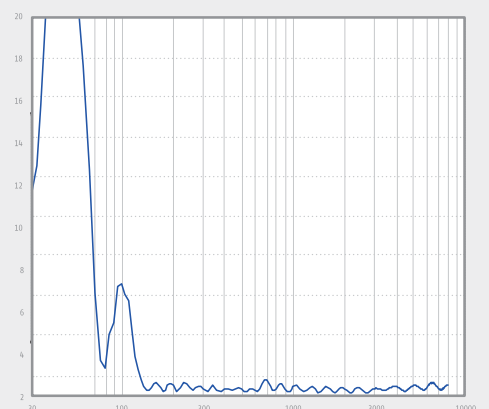
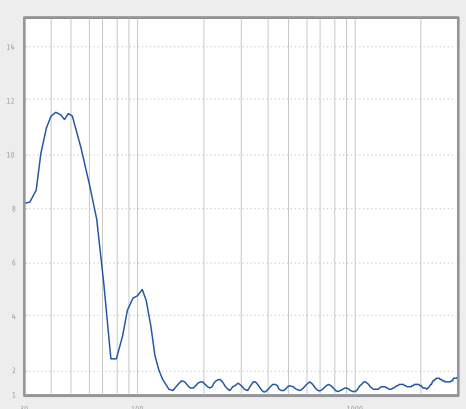
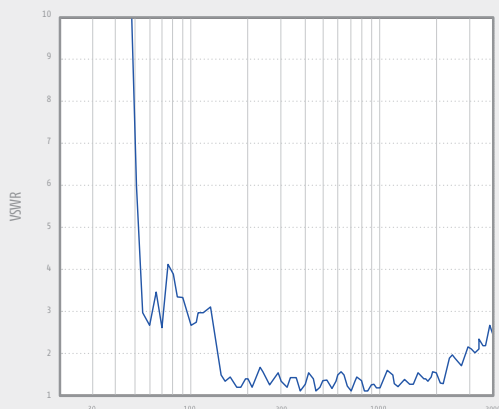
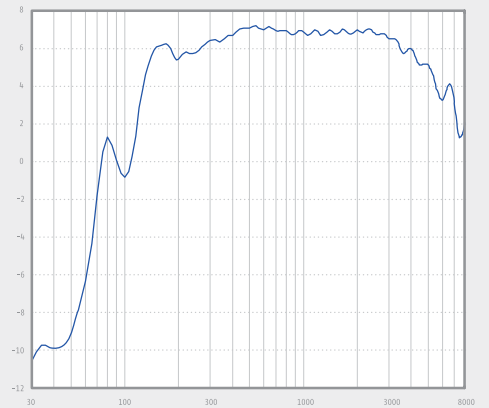

# DOUBLE STACKED LOG.-PERIODIC ANTENNA – AXL-80, 70 MHz – 4 GHz

for immunity tests and emission measurements

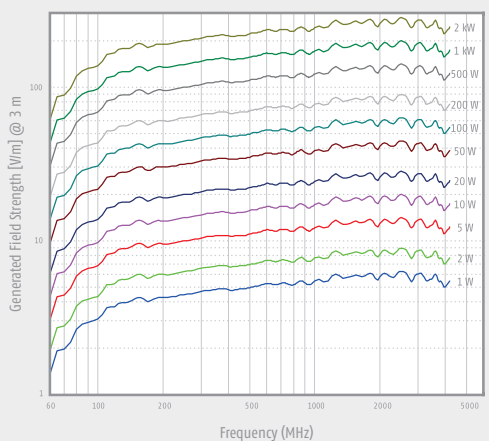
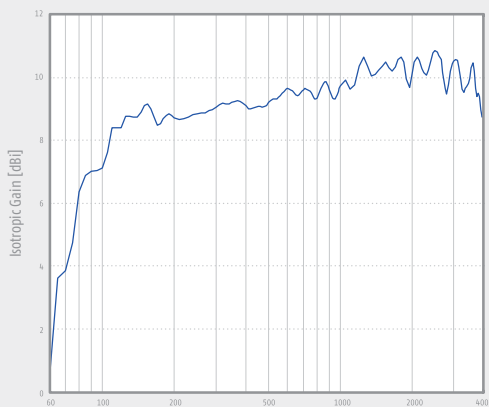
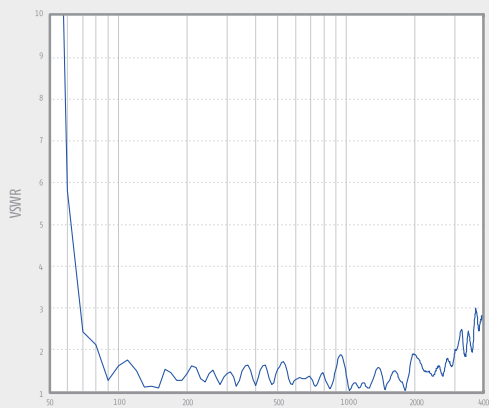
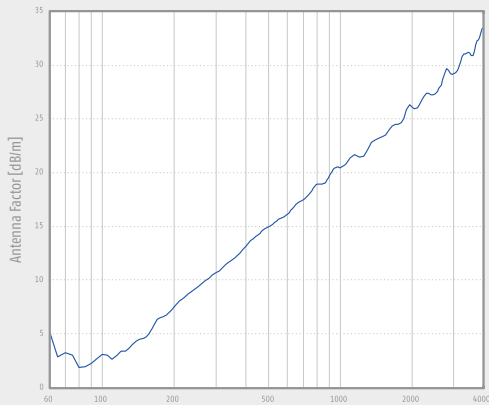

## Description

Double-stacked log.-periodic antennas have mainly been developed in order to reach the highest field strength levels acc. to automotive-, avionics- and military standards with as less as possible input power. Antenna gain saves amplifier power!

The stacked design helps to focus the directional pattern of the H-plane somewhat, resulting in a typical gain improvement of 2.5dB compared to an ordinary LP antenna. This is especially important for immunity testing, where a maximum field strength and a good field uniformity is required. The beam-width in the E-plane and the H-plane are nearly identical, providing an optimized illumination of the EUT with minimized ground reflection influence.

Further the cross polar rejection of the AXL-80 is excellent and the high and flat gain of about 9dBi over a broad frequency range is the main advantage of the AXL-80. Because of its physical dimensions the main application of the AXL-80 is in bigger anechoic chambers / test sites for radiated immunity tests and emission measurements. From its technical / mechanical design it is a double-stacked log.-periodic antenna, consisting of two excellent ordinary log.-periodic structures. For easy transport and storage it is possible to remove the rear elements of the antenna, which are fixed by fast links.

## Technical specifications

Frequency range	70 MHz - 4 GHz
Max. input power	1.5 kW (intermitt.)
(N-connector):	1 kW (cont.)
Max. input power	3 kW (intermitt.)
(7 / 16-connector)	2 kW (cont.)
Nominal impedance:	50 Ω
Isotropic gain:	9 ± 2 dBi
Antenna factor	2 ... 32 dB/m
Standing wave ratio SWR typ.:	1.6 (f < 3GHz)
Front to back ratio:	8 - 22 dB
Cross polarization	> 30 dB
3 dB beamwidth typ. (E-Plane):	60° - 75°
3 dB beamwidth typ. (H-Plane):	50° - 65°
Dimensions (W x L x D) in mm:	1480 x 1480 x 1340
Weight:	8.1 kg
Fixation	∅ 22mm mounting tube
Use:	Emission measurements Radiated immunity tests

# DOUBLE STACKED LOG.-PERIODIC ANTENNA – AXL-80S, 70 MHz – 4 GHz

with folded elements for immunity tests and emission measurements with limited space

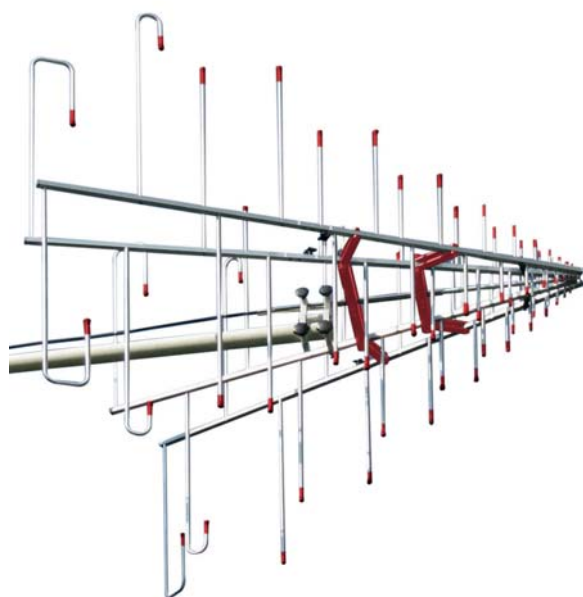

## Description

The AXL-80S has the same antenna design as the AXL-80 (see page 4), but with folded rear elements. The folded rear elements reduce the width of the AXL-80S to 1,480 mm. That is important for some standards, in order to keep the minimum distance of 25cm to the floor when testing in vertical polarization. But also for applications in smaller anechoic chambers the reduced dimensions might be an advantage.

### Technical specifications

Frequency range	70 MHz – 4 GHz
Max. input power	1.5 kW (intermitt.)
(N-connector):	1 kW (cont.)
Max. input power	3 kW (intermitt.)
(7 / 16-connector)	2 kW (cont.)
Nominal impedance:	50 $\Omega$
Isotropic gain:	9 $\pm$ 3 dBi
Antenna factor	2 ... 32 dB/m
Standing wave ratio SWR typ.:	1.6 (f < 3GHz)
Front to back ratio:	8 – 22 dB
Cross polarization	> 30 dB
3 dB beamwidth typ. (E-Plane):	60° – 75°
3 dB beamwidth typ. (H-Plane):	50° – 65°
Dimensions (W x L x D) in mm:	1480 x 1480 x 1340
Weight:	8.1 kg
Fixation	$\varnothing$ 22mm mounting tube
Use:	Emission measurements Radiated immunity tests

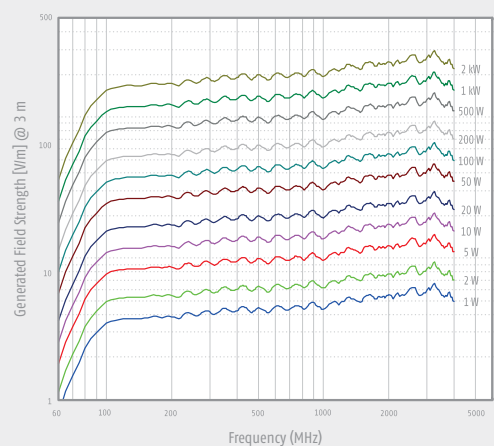
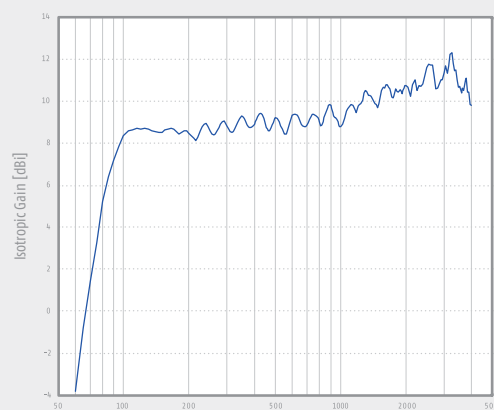
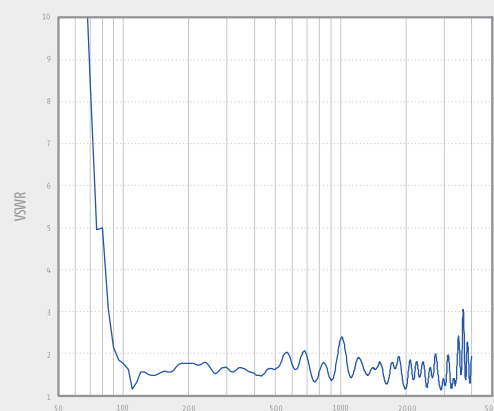
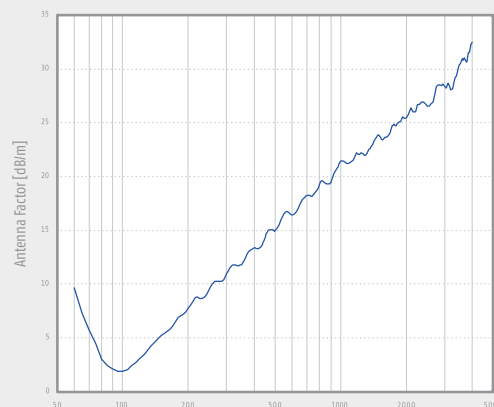

# STACKED LOG.-PERIODIC ANTENNA – AXL-80ES, 80 MHZ – 2.7 GHz

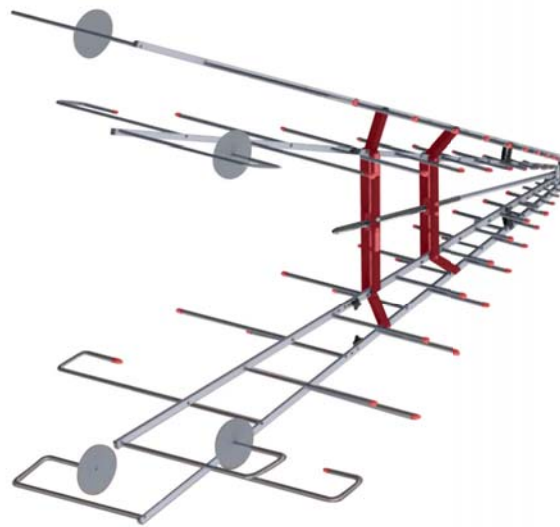
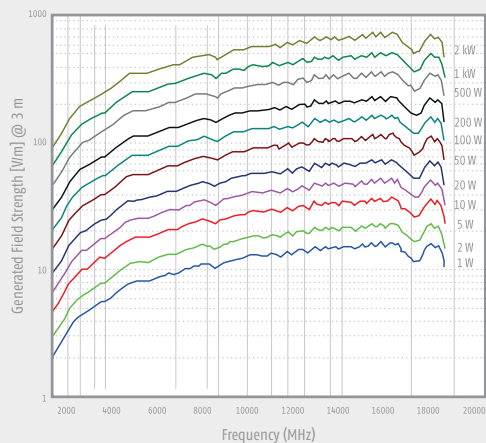
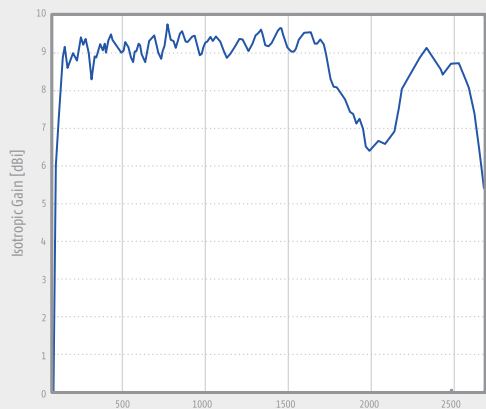
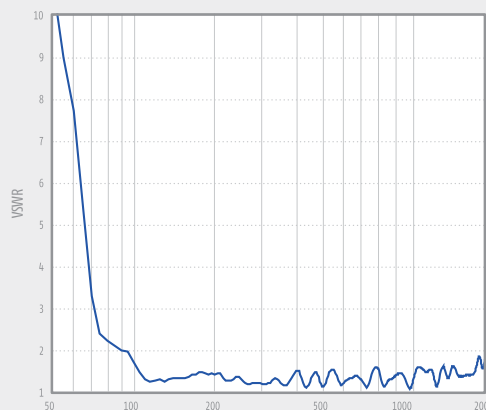
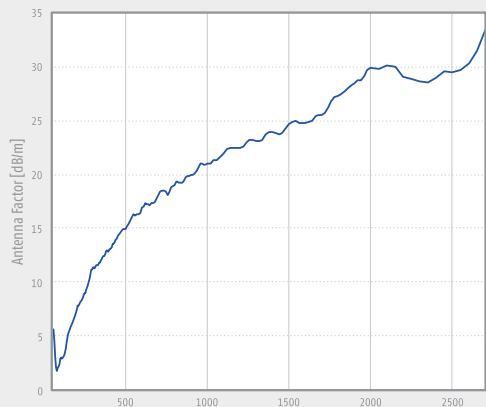

## Description

The AXL-80ES special is nearly identical like the AXL-80E but with folded longest elements and smaller structure angle.

The stacked Log Periodic Dipole Antenna (Stacked LPDA) consists of two ordinary Log.-Per. structures. The excellent characteristics (flat gain over a large bandwidth, low SWR) of the ordinary LPDA designs could be maintained using the stacked LPDA design. The stacked design helps to focus the directional pattern of the H-plane somewhat, resulting in a typical gain improvement of 2.5 dB compared to an ordinary LP antenna. This is especially important for immunity testing, where a maximum field-strength and a good field uniformity is required. The beam width in the E-Plane and the H-plane are nearly identical, providing an optimized illumination of the EUT with minimized ground reflection influence. Further the cross polar rejection of the AXL-80ES is excellent. The fast-links allows to disassemble the rear elements without any need for further tools within a few seconds. These fast-links divide the antenna into five parts, which can be stored and transported easily.

## Technical specifications

Frequency range	80 MHz – 2.7 GHz
Max. input power (N-connector)	1 kW (const.) 1.5 kW (intermitt.)
Max. input power (7 / 16-connector)	2 kW (cont.) 3 kW (intermitt.)
Nominal impedance:	50 Ω
Standing wave ratio SWR typ.:	< 1.5
3 dB beamwidth typ. (E-Plane):	47°-87°
3 dB beamwidth typ. (H-Plane):	41°-107°
Dimensions (W x L x D) in mm:	1500x1740x1400
Weight:	9.8 kg
Fixation	∅ 22mm mounting tube



# STACKED LOG.-PERIODIC ANTENNA – AXL-80-6G, 70 MHz – 10 GHz

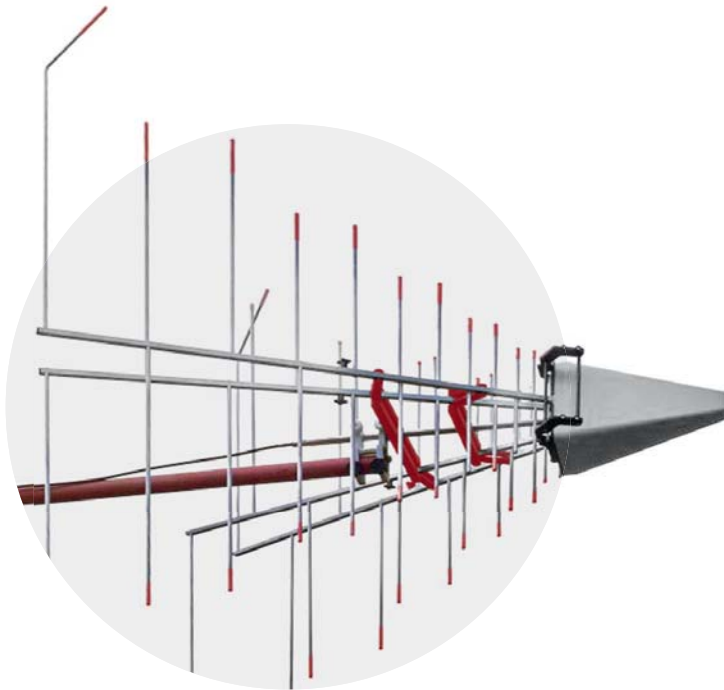

## Description

The AXL-80-6G was especially designed for wideband immunity tests. The unique AXL-80-6G is able to cover the entire frequency range from 80 MHz to 10 GHz with a typical isotropic farfield gain of 8.6 dBi with a ripple of less than  $\pm 2.3$  dB only. This unrivaled bandwidth was achieved by combining the both well proven antenna designs AXL-80 and the MAX-9. The AXL-80-6G does provide the optimum out of gain and field uniformity at the same time as well as both basic antennas do. For mechanical reasons the antenna comes with an ultra-low loss radome cover to protect the radiating elements at the antenna tip. By default, the AXL-80-6G is equipped with fast links for the rear radiating elements, which are responsible for the low frequency range between 70 MHz and 180 MHz. These unique fast links allow the quick disassembly of the antenna within less than a minute into five handling-friendly parts. The rear radiating elements can be omitted if there is no need to cover the frequency range from 70 MHz to 180 MHz.

## Technical specifications

Frequency range	70 MHz – 10 GHz
Max. contin. Power	1.5 kW (f < 100 MHz) 500 W (f < 1 GHz) 200 W (f < 8 GHz)
Nominal impedance:	50 $\Omega$
Pattern Type	directional
Isotropic Gain	8.6 dBi $\pm$ 2.3 dB
VSWR typ.:	< 2
Dimensions (W x L x D) in mm:	1690 x 1640 x 2002
Weight:	10.2 kg
Fixation	$\varnothing$ 22mm mounting tube
Connector	Typ N

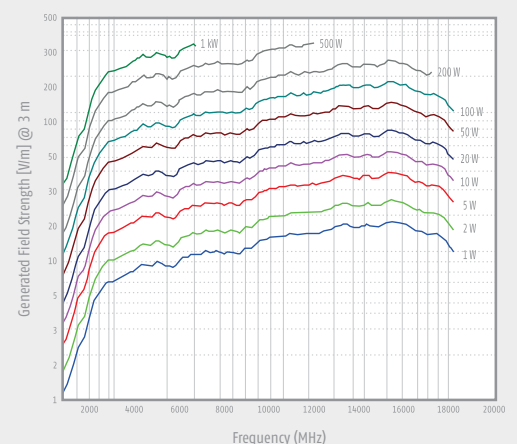
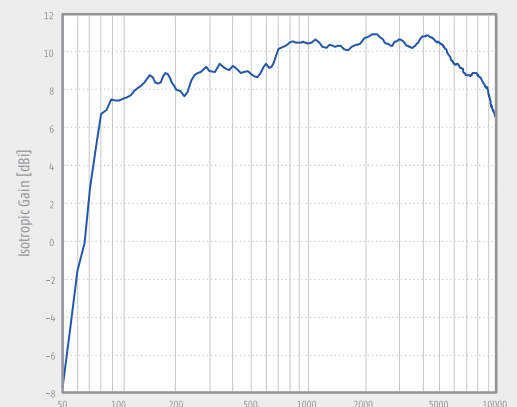
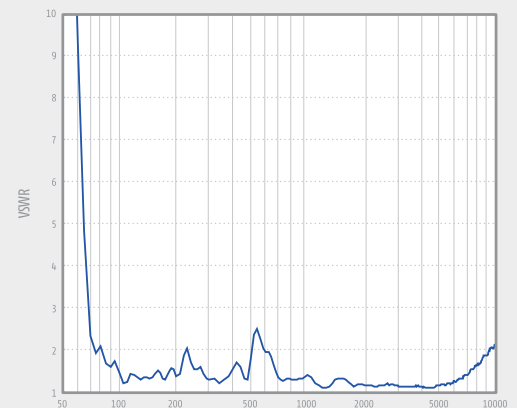
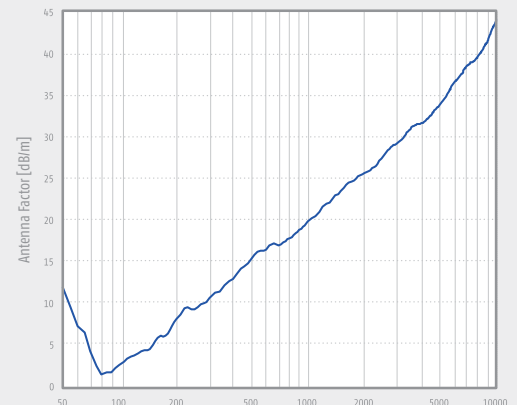

# DOUBLE STACKED LOG.-PERIODIC ANTENNA – AXL-200, 150 MHz – 4 GHz

for immunity tests acc. to automotive standards

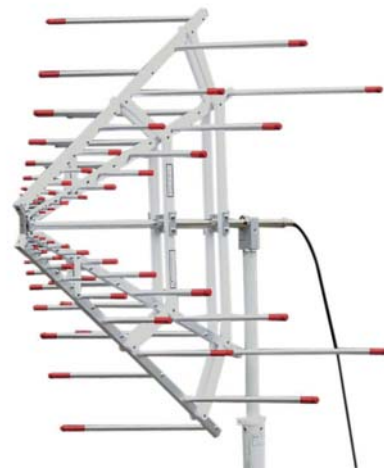
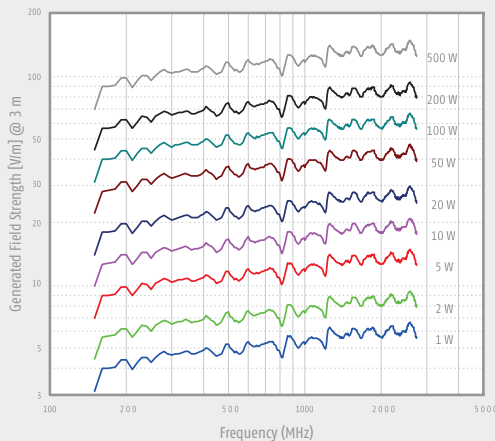
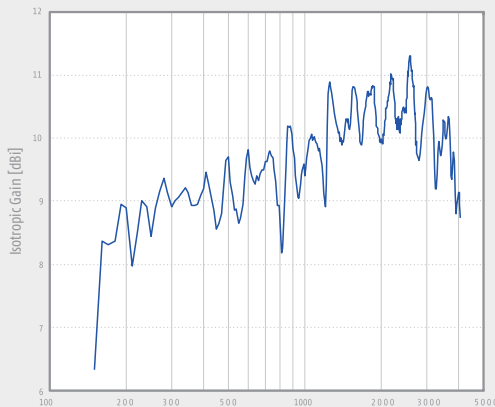
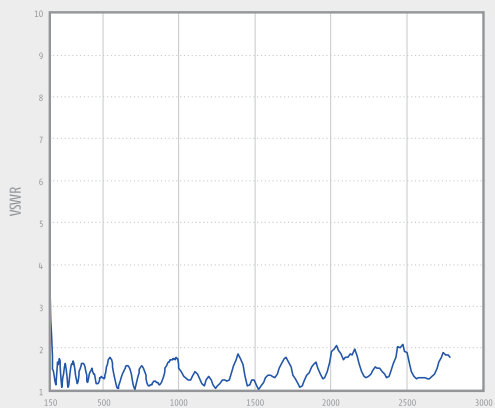
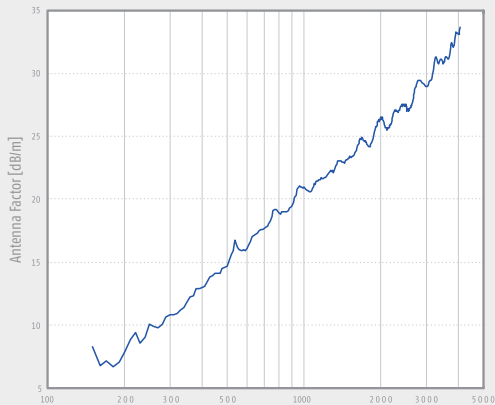

## Description

The AXL-200 has especially been designed for the generation of high field strength levels acc. to automotive immunity standards. The small dimensions of the antenna does also allow to keep the min. required distance of 25cm to the floor, when testing in vertical polarization.

From the mechanical design it's a double-stacked logarithmic periodic antenna, consisting of two excellent ordinary log.-periodic structures. This design guarantees a high and flat gain of 9-10dBi over a large bandwidth and a low SWR.

The stacked design helps to focus the directional pattern of the H-plane somewhat, resulting in a typical gain improvement of ca. 2 dB compared to an ordinary LP antenna. This is especially important for immunity testing, where a maximum field strength and a good field uniformity is required. The beamwidth in the E-plane and the H-plane are nearly identical, providing an optimized illumination of the EUT with minimized ground reflection influence. Further the AXL-200 has an excellent cross-polar rejection.

## Technical specifications

Frequency range	150 MHz – 4 GHz
Max. input power (N-connector):	2 kW (intermitt.) 1 kW (cont.)
Max. input power (7 / 16-connector)	3 kW (intermitt.) 2 kW (cont.)
Nominal impedance:	50 Ω
Isotropic gain:	9 ... 10 ± 1 dBi
Antenna factor	8 ... 24 dB/m
Standing wave ratio SWR typ.:	< 1.5
Front to back ratio:	> 16 dB
Cross polarization	> 30 dB (200 MHz ... 1 GHz)
3 dB beamwidth typ. (E-Plane):	64° - 53°
3 dB beamwidth typ. (H-Plane):	63° - 44°
Dimensions (W x L x D) in mm:	930 x 890 x 940
Weight:	4.6 kg
Fixation	Ø 22mm mounting tube
Use:	Radiated immunity tests and Emmission measurements acc. to automotive standards

# STACKED LOG.-PERIODIC ANTENNA – MAX-9, 600 MHz – 10.5 GHz

for immunity tests and emission measurements



## Description

Stacked logarithmic-periodic broadband antenna for radiated immunity tests and emission measurements in the microwave frequency range. The antenna structure is made of laser-cut brass.

For protection of the fine antenna structure against damage the antenna is equipped with a low loss plastic protection cover. The MAX-9 is especially suitable for immunity testing acc. to IEC 61000-4-3 because of its good field uniformity. Further outstanding characteristics of the MAX-9 are the wide bandwidth, the nearly constant high gain, very good impedance matching as well as equal beamwidth in E- and H-plane.

## Technical specifications

Frequency range	600 MHz – 10.5 GHz
Max input power	300 W (f = 1 GHz) 150 W (f = 6 GHz)
Nominal impedance:	50 Ω
Connection	type N female
Isotropic Gain	typ. 10.3 dBi ± 1.5 dB
Antenna factor	18 ... 41 dB/m
SWR typical	< 1.5 (f < 7 GHz)
Front to back ratio	> 25 dB typ.
Cross polarization rejection	> 30 dB typ.
Half-power beamwidth (E-plane)	46° ± 10°
Half-power beamwidth (E-Plane):	48° ± 10°
Dimensions (W x L x D) in mm:	460 (+215) x 270 x 270
Weight:	3.7kg
Fixation	∅ 22mm mounting tube
Use	Radiated immunity tests Emission measurements

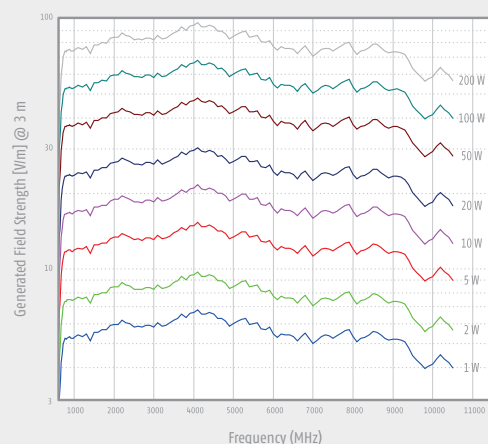
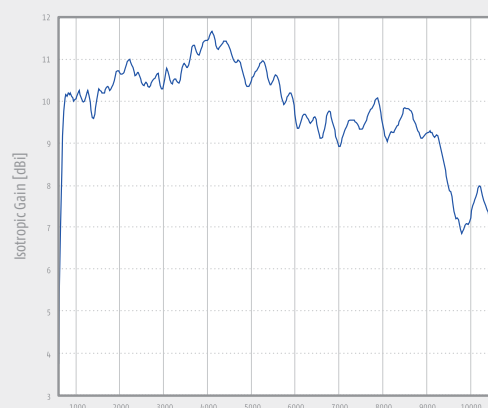
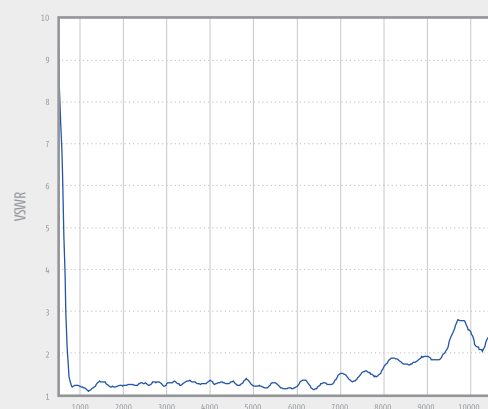
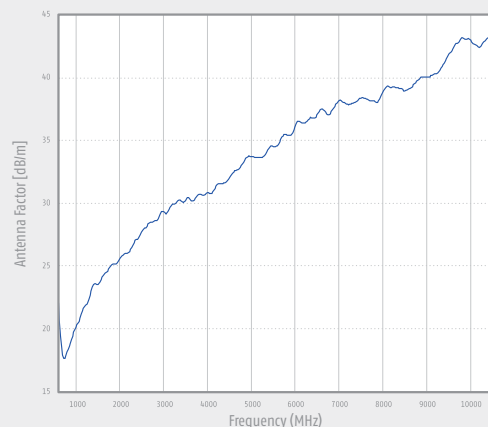

# STACKED LOG.-PERIODIC ANTENNA – MAX-18, 700 MHz – 20 GHz

for immunity tests and emission measurements

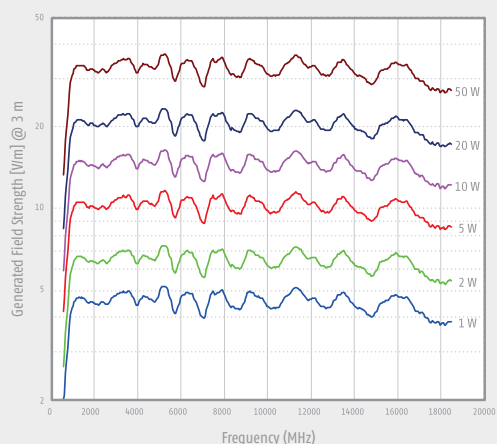
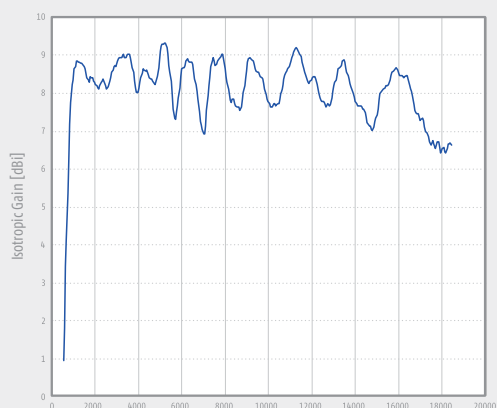
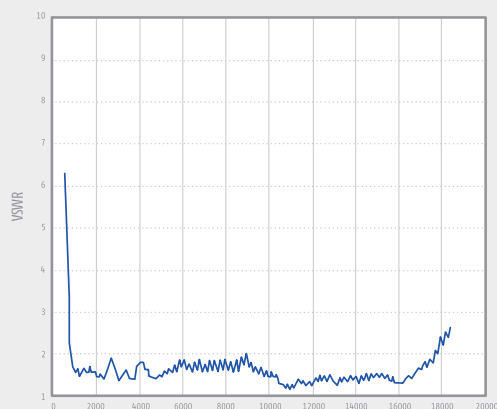
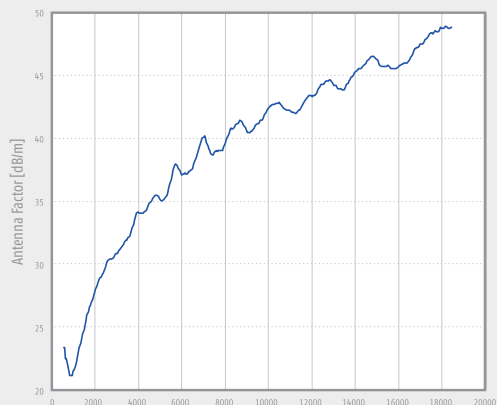

## Description

Stacked logarithmic-periodic broadband antenna for radiated immunity tests and emission measurements in the microwave frequency range. The antenna structure is made of laser-cut brass. For protection of the fine antenna structure against damage the antenna is equipped with a low loss plastic protection cover. The MAX-18 is especially suitable for immunity testing acc. to IEC 61000-4-3 because of its good field uniformity. Further outstanding characteristics of the MAX-18 are the wide bandwidth, the nearly constant high gain, very good impedance matching as well as equal beamwidth in E- and H-plane.

## Technical specifications

Frequency range	700 MHz – 20 GHz
Max input power	50 W
Nominal impedance:	50 $\Omega$
Connection	type N female
Isotropic Gain	typ. 8.6 dBi $\pm$ 1 dB
Antenna factor	20 ... 49 dB/m
SWR typical	< 2
Dimensions (W x L x D) in mm:	490 x 270 x 270
Weight	1.2 kg
Front to back ratio	> 25 dB typ.
Cross polarization rejection	> 28 dB typ.
Half-power beamwidth (E-plane)	58°
Half-power beamwidth (H-plane)	60°

# BROADBAND HORN ANTENNA – HAX-6, 500 MHz – 6 GHz

for immunity tests and emission measurements



## Description

The horn antennas HAX offer a very low SWR in their nominal frequency range and a very broad bandwidth. The gain increases with frequency up to approx. 18 dBi. The increasing gain with frequency helps to compensate cable losses.

The HAX series is suitable for both, transmission and receiving applications. The maximum allowed input power is only limited by the female N-connector. The detailed manual of the calibrated test antennas includes gain, antenna factor, SWR and directional patterns. The antenna is mounted with the 22 mm tube, equipped with a index ring for quick changes of polarization without using tools.

### Technical specifications

Frequency range	500 MHz – 6 GHz
Max input power	limited only by N-connector
Connection	type N female
Gain	6 ... 18 dBi
Antenna factor	19 ... 29 dB/m
Standing wave ratio SWR typ.:	< 2
Dimensions (W x L x D) in mm:	424 x 314 x 820
Weight	4.1 kg
Fixation	∅ 22mm mounting tube
Material	aluminium
Use	Raiated immunity tests Emission measurements

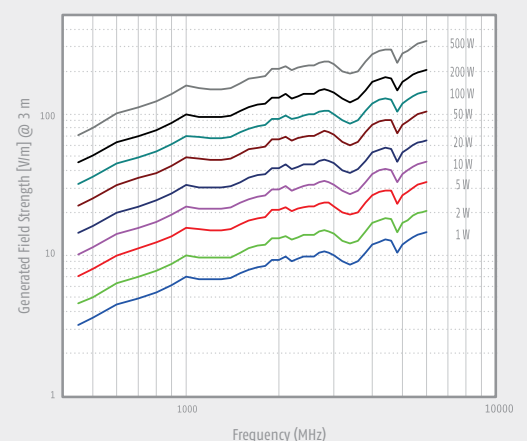
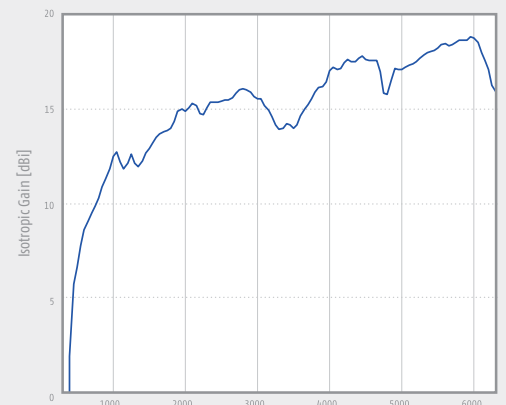
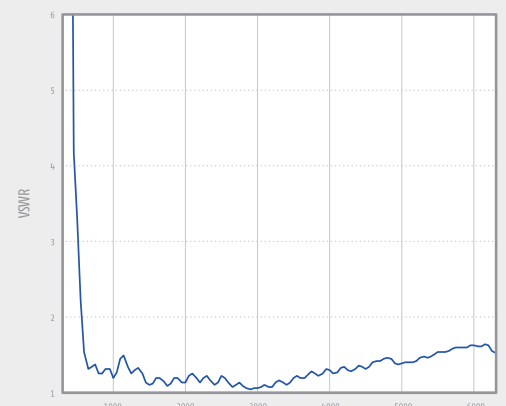
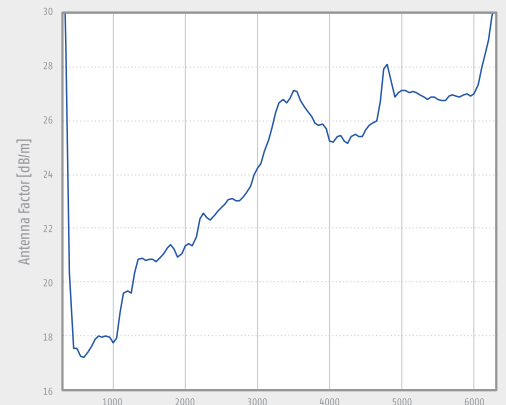

# BROADBAND HORN ANTENNA – HAX-6-KFZ, 800 MHz – 6.2 GHz

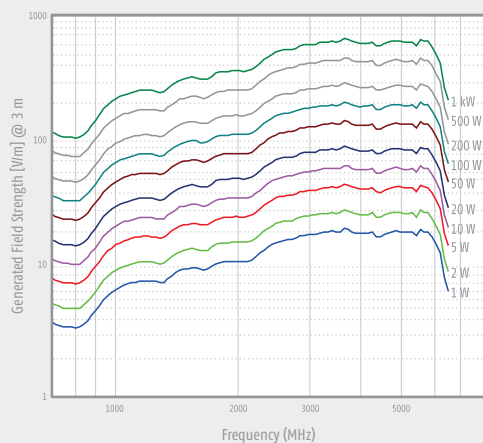
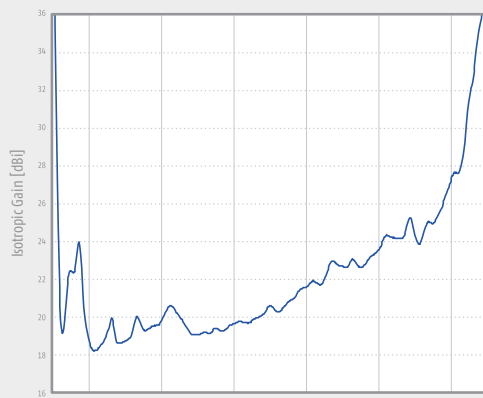
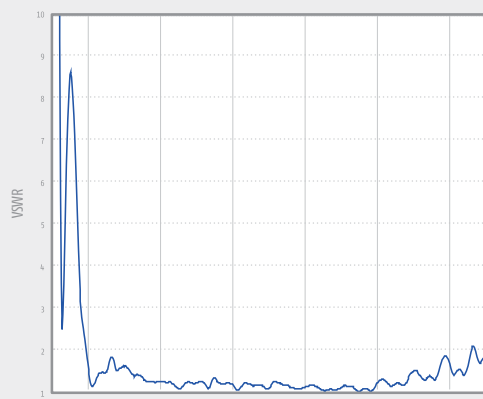
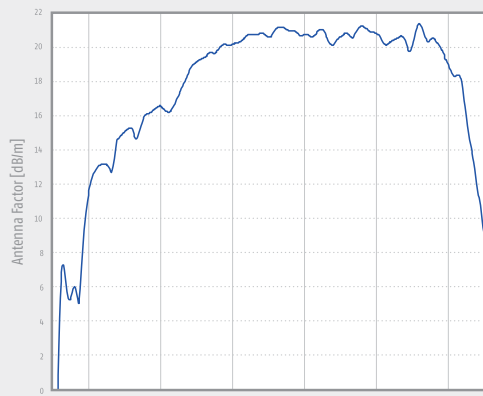

## Description

The broadband horn antenna HAX-6-Kfz is a linear polarized high gain antenna for the frequency range 800 MHz up to 6.2 GHz. The gain increases from 11 dBi at 1 GHz up to more than 20 dBi at higher frequencies.

### Technical specifications

Frequency range	800 MHz – 6.2 GHz
Max input power (N connector female)	1 kW @1 GHz
Max input power (Option: 7/16 connector female)	1.7 kW @1 GHz
Isotropic Gain	min 11 dBi (f > 1 GHz)
Antenna factor	see data on the left side
Nominal impedance:	50 Ω
Standing wave ratio SWR max.	<2.3 (f > 1 GHz)
Standing wave ratio SWR typ.	1.3 (f > 1 GHz)
Polarisation	linear
3 dB Beamwidth typ. (E-plane)	48° - 11°
3 dB Beamwidth typ. (H-plane)	48° - 12°
Dimensions (W x L x D) in mm:	680 x 435 x 440
Weight	7.6 kg
Fixation	3/8" + M12

# BROADBAND HORN ANTENNA – HAX-18, 800 MHz – 18 GHz

for immunity tests and emission measurements



## Description

The horn antennas HAX offer a very low SWR in their nominal frequency range and a very broad bandwidth. The gain increases with frequency up to approx. 16 dBi. The increasing gain with frequency helps to compensate cable losses.

The HAX series is suitable for both, transmission and receiving applications. The maximum allowed input power is only limited by the female N-connector. The detailed manual of the calibrated test antennas includes gain, antenna factor, SWR and directional patterns. The antenna is mounted with the 22 mm tube, equipped with a index ring for quick changes of polarization without using tools.

## Technical specifications

Frequency range	800 MHz – 18 GHz
Connection	N-female
Isotropic Gain	6 ... 18 dBi
Antenna factor	24 ... 50 dB/m
Nominal impedance:	50 Ω
SWR typical	≈1.5
Front to back ratio	> 25 dB (f > 1.3 GHz)
Cross polarization rejection	> 25 dB (1 GHz ... 18 GHz)
3 dB Beamwidth typ. (E-plane)	90°-10°
3 dB Beamwidth typ. (H-plane)	60°-10°
Dimensions (W x L x D) in mm:	245 x 195 (408) x 142
Weight	1.3 kg
Fixation	∅ 22mm mounting tube
Use	Radiated immunity tests Emission measurements

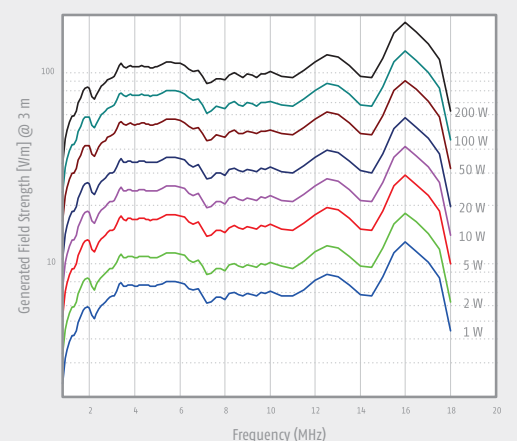
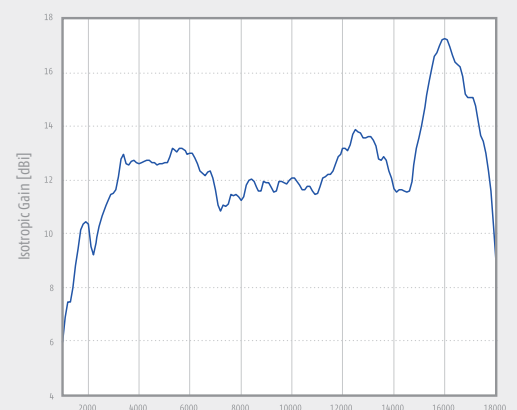
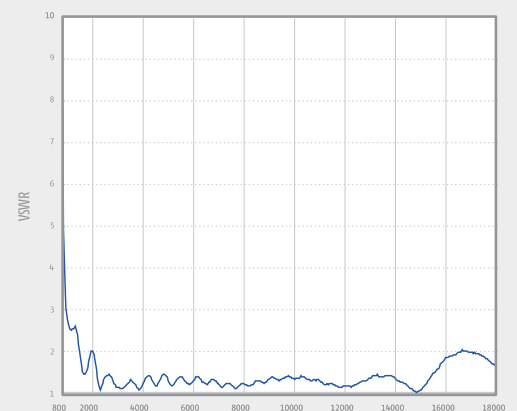
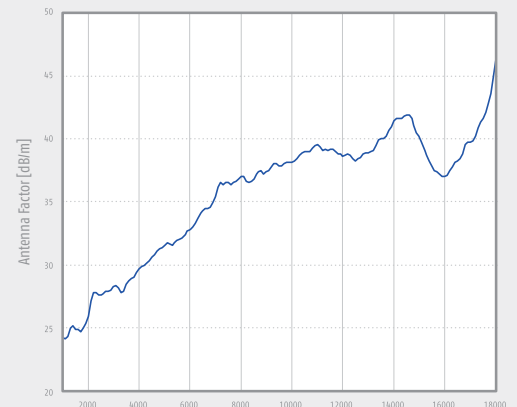

# BROADBAND HORN ANTENNA – HAX-40, 14 GHz – 40 GHz

for immunity tests and emission measurements



## Description

The horn antennas HAX offer a very low SWR in their nominal frequency range and a very broad bandwidth. The gain increases with frequency up to approx. 16 dBi. The increasing gain with frequency helps to compensate cable losses.

The HAX series is suitable for both, transmission and receiving applications. The maximum allowed input power is only limited by the female N-connector. The detailed manual of the calibrated test antennas includes gain, antenna factor, SWR and directional patterns. The antenna is mounted with the 22 mm tube, equipped with a index ring for quick changes of polarization without using tools.

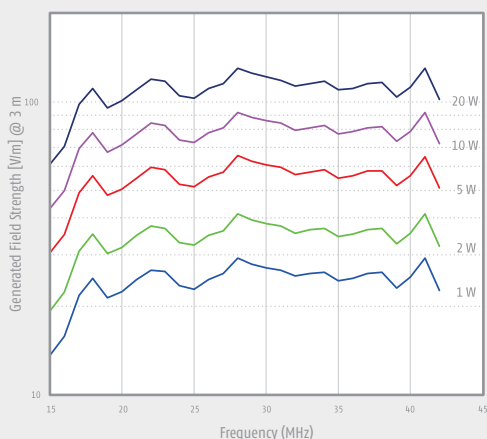
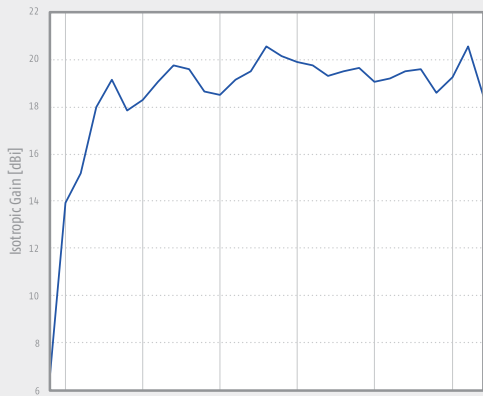
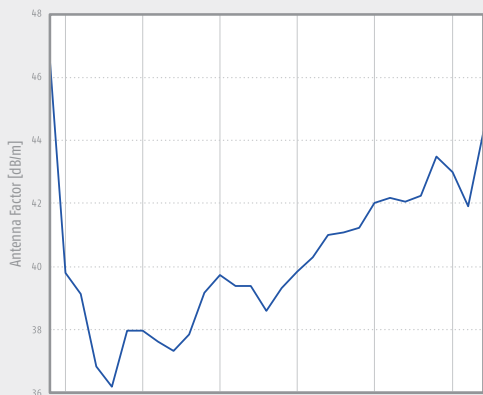

## Technical specifications

Frequency range	14 GHz – 40 GHz
Max input power	10 W (cont.) 25 W peak
Connection	SMA-compatible   female
Isotropic Gain	15 ... 20 dBi
Antenna factor	38 ... 45 dB/m
SWR typical	≈ 2
Front to back ratio	> 30 dB
Cross polarization rejection	> 25 dB
3 dB Beamwidth typ. (E-plane)	13° – 21°
3 dB Beamwidth typ. (H-plane)	14° – 23°
Dimensions (W x L x D) in mm:	75 x 86 x 60
Weight	0.3 kg
Fixation	3/8", 1/4"
Use	Radiated immunity tests Emission measurements



# ACTIVE ROD ANTENNA – SAX-10, 9 kHz – 30 MHz

for E-field measurements



## Description

The active monopole antenna SAX-10 consists of a vertical rod and an impedance matching amplifier. The rod has a standard length of 1m (other rod length on request) and can be considered as short compared to the wave length in the frequency range 9 kHz–30MHz. The conversion factor is independent of the frequency because of the extremely high impedance of the matching amplifier. The circuit gives best results of noise and intermodulation for a conversion factor (antenna factor) of +10 dB and sensitive measuring receivers are able to use the whole dynamic range of the antenna. For very high field strength, an optional plug-in attenuator reduces the amplification by 20 dB.

In order to avoid absolutely any influence by the mains, power supply, voltage regulator a. o., the SAX-10 has built-in NiMH rechargeable batteries. The typical operation time is at least 50 hours. Charging time is 2-4 hours using the quick charger.

Rod antenna and amplifier cabinet are made of aluminium. The top plate can be fixed to the metal ground plane (counterpoise) with 4 screws. The connectors and controls are situated below the two plates. The rod length begins exactly at the top plate.

## Technical specifications

Frequency range	9 kHz – 30 MHz
Antenna factor	+10 dB/m $\pm$ 1.5 dB
Upper limit of field strength measurement	1 V/m (F=1 MHz, 1 dB compression) Input attenuator for higher field strength optional
Lower limit of field strength measurement	Limitation by internal noise: Typ. -3 dB $\mu$ V/m / 10 MHz, CISPR-Quasipeak, 9 kHz bandwidth Typ. -8 dB $\mu$ V/m / 10 MHz, average detector, 9 kHz bandwidth
Output of the monopole amplifier	BNC-connector, fem., 50 $\Omega$ nom.
Power supply	9.6 V / 1100 mAh NiMH
Dimensions and weight:	Length including thread connection 1 m, weight approx.: 0.2 kg
Monopole (rod)	180 x 80 x 40 mm (WxHxD) without BNC-connector (female) and controls.
Amplifier	Top plate 220 x 120 mm, weight approx.: 0.7 kg
Construction of the monopole (rod)	Aluminium rod 16 mm diameter with thread-hole M8
Construction of the amplifier	Cabinet made of aluminium profiles. Top plate 3mm aluminium material
Threads for tripods	1/4", 3/8"

# ACTIVE LOOP ANTENNA – LAX-10, 9 kHz – 30 MHz

for H-field measurements

## Application

The active loop antenna LAX-10 can be used for the frequency selective measurement of magnetic fields in the long wave, mid wave and short wave frequency ranges. It can be used for testing according to CISPR, MIL, FCC, EN, ISO, ANSI, ETSI and many other standards.



## Description

Active, shielded loop antenna with nearly constant antenna factor over the entire frequency range, battery driven to minimize disturbance influence from power line. Combined with a CISPR-16 EMI-receiver a convenient field strength measuring system with low noise and pulse measuring capabilities is composed. The LAX-10 can also be used with a spectrum analyzer. The shielded aluminum housing is equipped with rubber feet for desktop operation or can be mounted to a tripod using the female camera thread (3/8") at the bottom. A protection circuit against deep discharge provides a long battery lifecycle. The battery must be recharged after an automatic switch off.

A full battery charging period using the recommended charger takes around 5 hours. The PWR-switch must be set to OFF during the recharging period, otherwise no charging takes place. The charging connector is disabled while the PWR switch is set to ON (normal measuring operation), this avoids disturbances generated by the charger having an unwanted influence on the measurement.

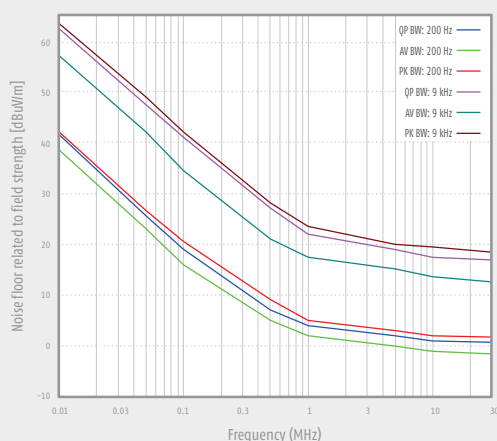
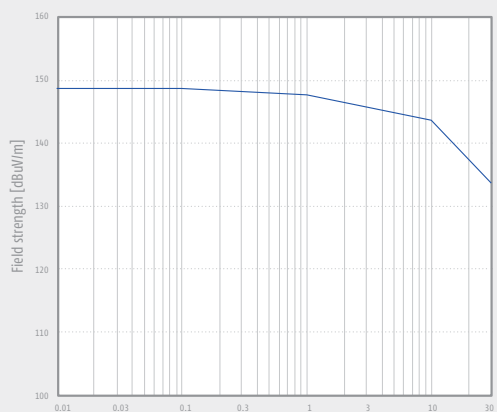
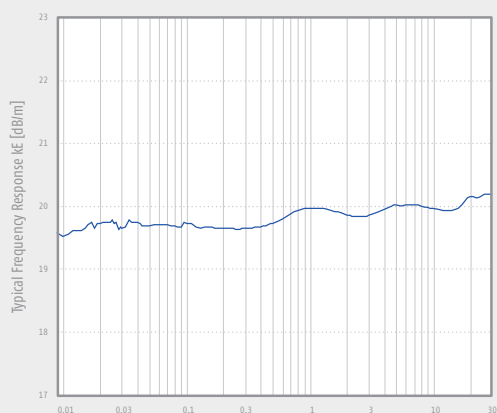

## Technical specifications

Nominal frequency range	9 kHz – 30 MHz
Connector, female	50 Ω, BNC
Antenna factor for fict. E-field strength	20 dB / m
Antenna factor for H-field strength	-31.5 dB / Ω
Loop diameter	0.5 m
Fieldstrength measuring range QP-Detector / 9 kHz IF-Bandwidth	30 – 130 dBμV/m
Fieldstrength measuring range AV-Detector / 200 Hz IF-Bandwidth	8 – 130 dBμV/m
Operation time with full battery capacity	typ 12h
Battery capacity	12 V NiMH 1.9 AH
Recommended charger	ACS 110
Mounting thread	1/4", 3/8"
Dimensions (W x L x D) in mm	520 x 585 x 120
Weight	1.9 kg

# BICONICAL ANTENNA FOR MICRO-WAVE FREQUENCIES – SAM-6, 1 – 6 GHz

for field strength radiation under free-space conditions, for example Site-VSWR measurements acc. to CISPR 16-1-4



## Description

The SAM-6 has two main applications: A passive field probe for frequency selective measurements of the generated field according to EN 61000-4-3, including the measurement of the uniform area. A further application is the validation of fully anechoic rooms for measurements above 1 GHz according to the Site-VSWR method, described in CISPR 16-1-4. In conjunction with the SAM-18 a frequency range from 1 to 18 GHz can be covered with excellent antenna performance. Accepting some limitations (i.e. antenna factor and VSWR increase, symmetry reduction) the SAM-6 can be used from 0.5 GHz on. The validation of test sites with commonly used microwave antennas (e.g. log.-per. or horn antennas) leads to insufficient results, since these directive gain antennas with concentrated directional pattern do not take the test site characteristics into account.

## Application

The typical applications of the microwave biconical antenna are the evaluation of test sites, the (frequency selective) field strength measurement and the generation of defined field strength (e.g. ERP or EIRP). Thanks to the wide bandwidth there is no need for a time consuming change of the antenna elements as required when operating with tuned half-wave dipoles. The biconical elements allow a continuous sweep over the complete frequency range. Because of the dipole-like directional pattern, the fixed phase center and the high power handling capability the SAM-6 may replace tuned half-wave dipoles in many applications. The SAM-6 is not intended for emission testing with very low limits, horn and log.-per. antennas are better matched for this purpose because of their better antenna factor. A typical application of the SAM-6 is the use as a (highly linear) broad-band near field probe thanks to its small dimensions.

### Technical specifications

Frequency range	1 GHz – 6 GHz
Max input power	20 W
N-connector, female	50 $\Omega$
Isotropic Gain (1 – 6 GHz)	typ. -10 ... +2 dBi
Antenna factor	32 ... 48 dB/m
SWR typical (1.3 – 6 GHz)	1.5 – 5
Balun (low loss)	1:1
Inversion symmetry (1 – 6 GHz)	typ. < 0.5 dB
Cross polarization rejection	< - 20 dB
Half-power beamwidth (E-plane):	84° – 45°
Mounting tube	LH = 560mm, d = 22mm
Index ring	LR = 190mm
Element length total	LE = 50mm
Element diameter	D = 28mm
Weight	400 g

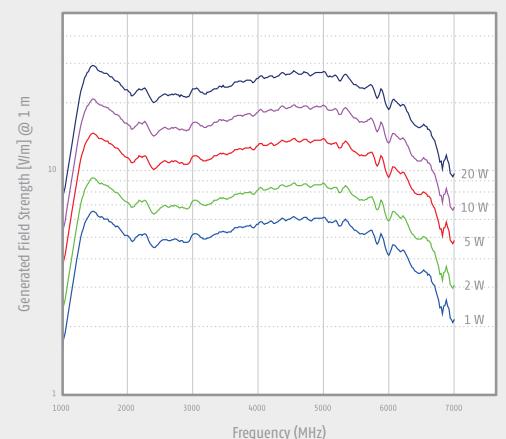
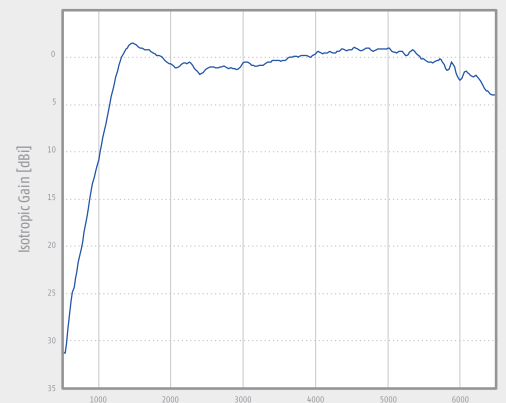
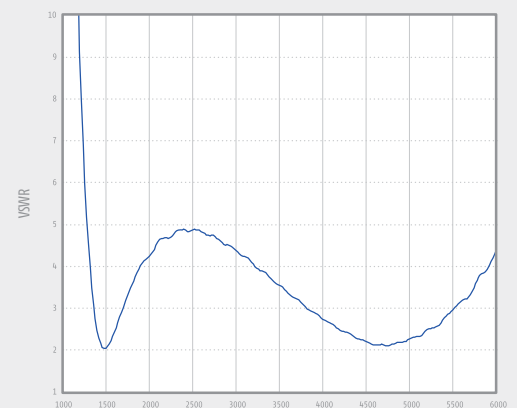
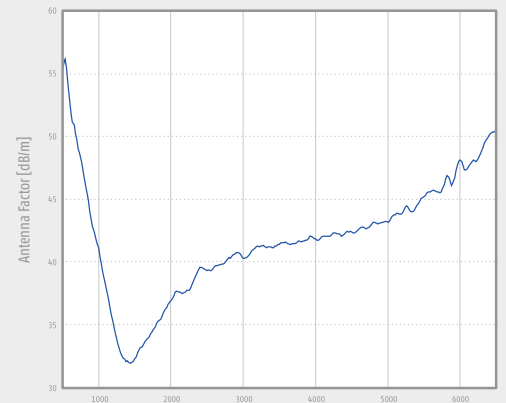

# BICONICAL ANTENNA FOR MICRO-WAVE FREQUENCIES – SAM-18, 3 – 18 GHz

for field strength radiation under free-space conditions, for example Site-VSWR measurements acc. to CISPR 16-1-4



## Description

The SAM-18 was designed because of the worldwide unavailability of omnidirectional or dipole-like broadband antennas operating above 3 GHz. Accepting some limitations (i.e. antenna factor and VSWR increase, symmetry reduction) the SAM-18 can be used from 1 GHz on. The validation of test sites with commonly used microwave antennas (e.g. Log-per. or horn antennas) leads to insufficient results, since these directive gain antennas with concentrated directional pattern do not take the test site characteristics into account.

## Application

The typical applications of the microwave biconical antenna are the evaluation of test sites, the (frequency selective) field strength measurement and the generation of defined field strength (e.g. ERP or EIRP). Thanks to the wide bandwidth there is no need for a time consuming change of the antenna elements as required when operating with tuned half-wave dipoles. The biconical elements allow a continuous sweep over the complete frequency range. Because of the dipole-like directional pattern, the fixed phase center and the high power handling capability the SAM-18 may replace tuned half-wave dipoles in many applications. The SAM-18 is not intended for emission testing with very low limits, horn and log.-per. antennas are better matched for this purpose because of their better antenna factor. A typical application of the SAM-18 is the use as a (highly linear) broadband nearfield probe thanks to its small dimensions.

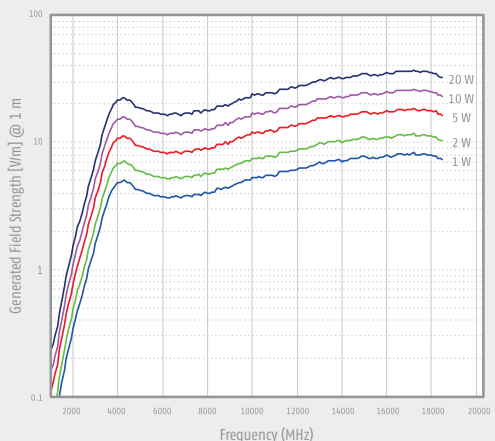
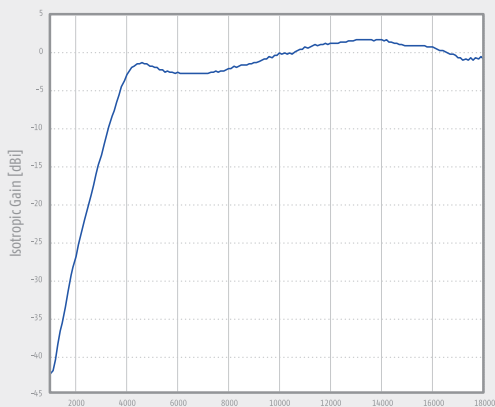
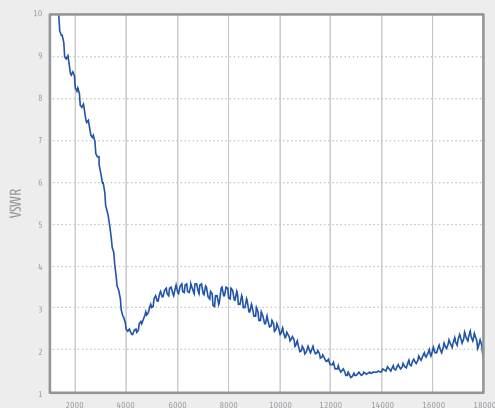
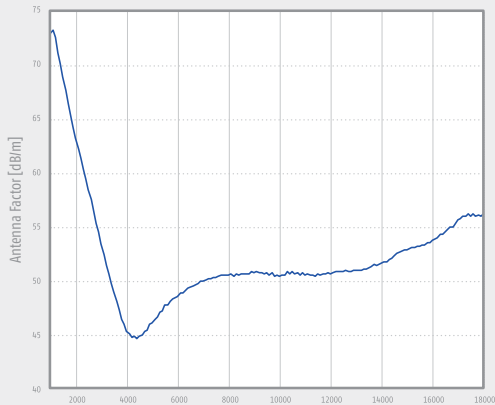

## Technical specifications

Frequency range	3 GHz - 18 GHz
Max input power	10 W
N-connector, female	50 Ω
Isotropic Gain (3.5 - 18 GHz)	typ. -4 ... +3 dBi
Antenna factor	43 ... 53 dB/m
SWR typical (4 - 18 GHz)	1.5 - 5
Balun (low loss)	1:1
Inversion symmetry (1 - 6 GHz)	typ. < 0.5 dB
Cross polarization rejection	< -20 dB
Half-power beamwidth (E-plane):	84° - 45°
Mounting tube	LH = 560mm, d = 22mm
Index ring	LR = 190mm
Element length total	LE = 20mm
Element diameter	D = 9mm
Weight	420 g

# BROADBAND PRE-AMPLIFIER

FPA-2, 9 kHz – 2 GHz, FPA-6A, 10 MHz – 6 GHz, FPA-6B, 9 kHz – 6 GHz



## Description

The FPA-x is a general purpose broadband pre-amplifier with high gain and low internal noise. The wide frequency range up to 2/6 GHz allows measurements acc. CISPR 22. Due to the high gain and the low noise figure the system noise is nearly independent of the other components including cable and receiver. These features make the FPA-x very useful for the measurement of very low limits, as required for CISPR 25. In this case it will be connected directly to the antenna. The amplifiers FPA-2 and FPA-6A are ESD protected to prevent defects by unintentional electrostatic discharge. The FPA offers a frequency range from 9 kHz to 6 GHz. For technical reasons it cannot be ESD-protected and special care is necessary. Nevertheless pre-amplifiers are generally ESD-sensitive devices, therefore it is very important to discharge coaxial cables before being connected. This is an essential precaution to protect the extremely small semiconductor structures operating in the microwave frequency range.

It must be noted that the use of pre-amplifier is generally not recommended for the measurement of impulsive signals. Such broadband noise is typical for many EMC measurements. This means that any broadband pre-amplifier is not suitable for EMC measurement of a broadband pulse spectrum. The FPA-x has an aluminum enclosure and uses N-Type flange connectors. A standard wall plug supply with +12 VDC output can be used. A suitable power supply for 230 V with Schuko socket is included in the delivery. The use of switching power supplies is not recommendable as they may cause higher levels of interference. An internal protection circuit slows down the rising and falling edge of the power supply voltage to prevent internal components and the receiver from being damaged by voltage spikes. 12 V auxiliary supplies from receivers and analyzers or batteries are also suitable if they can provide a continuous current of 0.14 A.

## Technical specifications

Type	FPA-2	FPA-6A	FPA-6B
Frequency range	9 kHz - 2 GHz	10 MHz - 6 GHz	9 kHz - 6 GHz
Noise figure	2.5 dB (1.0 GHz)	2.5 dB (1.0 GHz)	2.5 dB (1.0 GHz)
Gain	+ 30 dB	+ 28 dB	+ 28 dB
Amplitude flatness	< ± 3 dB	< ± 3 dB	< ± 3 dB
1 dB compression point at input	≥ -20 dBm (87 dBμV)	≥ -18 dBm (89 dBμV)	> 100 dBμV
Impedance	50 Ω	50 Ω	50 Ω
VSWR input / output	< 2:1	< 2:1	< 2:1
ESD protection	yes	yes	yes
Power supply	+ 12 V (± 2 V)	+ 12 V (± 2 V)	+ 12 V (± 2 V)
Current consumption	< 120 mA	< 130 mA	< 120 mA
Dimensions	82 x 38 x 27 mm	82 x 37 x 27 mm	88 x 41 x 27 mm
Weight	150 g	141 g	160 g

# BROADBAND PRE-AMPLIFIER – FPA-18, 1 GHz – 18 GHz

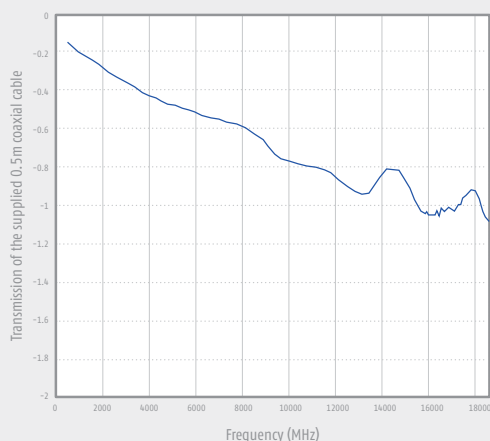
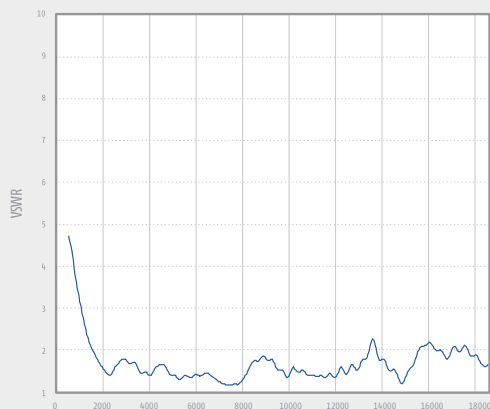
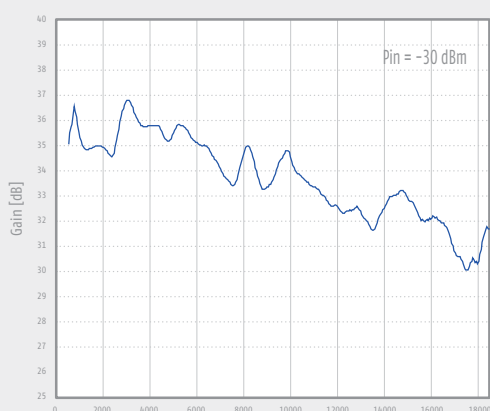

## Description

Low noise low power wideband amplifier for increasing sensitivity at field strength measurements and for general attenuation measurements up to 18 GHz. A power supply with 12 V / 300 mA DC (e.g. optional AC/DC adaptor, laboratory power supply, rechargeable battery) is required for operation. In- and output of the broadband amplifier are sensitive to electrostatic discharge. Therefore some precaution (discharging coaxial cables and persons) is required before touching the amplifier. The amplifier input comes with an SMA- female connector. A coaxial microwave cable of 0.5 m length is supplied to connect the antenna with the amplifier. The cable is equipped with N-male and SMA-male connectors.

Usually the amplifier should be installed very close to the antenna. The amplifier housing is equipped with rubber pads for placement on horizontal surfaces. Further there are 22 mm holes in the housing to accept the mounting tube of Frankonia antennas. The antenna mounting tube is usually oriented horizontally with the N-female output of the amplifier facing to ground. This avoids undesired bending of the coaxial cable.

## Technical specifications

Nominal Frequency range	1 GHz – 18 GHz
Usable Frequency range	0.5 GHz – 20 GHz
Connectors	50 Ω N / SMA
Fixation	∅ 22 mm tube
Gain	typ. 33 dB ± 2.5 dB
Gain min.	> 28 dB
Max. input power	-10 dBm (97 dBμV)
SWR typ.	< 2
Noise figure	2 dB
Supply voltage	12V – 15 V / DC
Current consumption	250 – 300 mA
Power supply via female banana sockets	4mm
Weight:	600 g
Dimensions (W x L x D) in mm	142 x 90 x 48

# BROADBAND PRE-AMPLIFIER – FPA-26, 18 GHz – 26.5 GHz



## Description

Low noise low power wideband amplifier for increasing sensitivity at field strength measurements and for general attenuation measurements up to 26.5 GHz. A power supply with 12 V / 300 mA DC (e.g. optional AC/DC adaptor, laboratory power supply, rechargeable battery) is required for operation. In- and output of the broadband amplifier are sensitive to electrostatic discharge.

Therefore some precaution (discharging coaxial cables and persons) is required before touching the amplifier. The amplifier input comes with SMA-female connectors. A coaxial microwave cable of 0.5 m length is supplied to connect the antenna with the amplifier. The cable is equipped with SMA-male connectors. The amplifier is equipped with a female 3/8" camera thread to be connected to a mast, e.g. to FSM-1.6. The antenna itself is mounted with another 3/8" screw at the amplifier base. The polarization swivel can easily be achieved within seconds by a further screw in 45° steps using fixing bolts for indexing.

It is very important to avoid bending and torsion of the microwave cable, otherwise persistent damage may be a result. Therefore we recommend to mount the antenna in a way that the antenna connector points into the opposite direction as the RF-input of the amplifier. This allows a smooth routing the microwave cable with a wide bending radius.

## Technical specifications

Nominal Frequency range	18 GHz - 26.5 GHz
Usable Frequency range	12 GHz - 28 GHz
Connectors	50 Ω SMA
Mounting thread	3/8"
Gain	typ. 33 dB ± 2 dB
Gain min.	30 dB
Max. input power	-20 dBm (87 dBμV)
SWR typ.	< 2
Noise figure	3.5 dB
Supply voltage	12V - 15 V / DC
Current consumption	250 - 300 mA
Power supply via female banana sockets	4mm
Weight:	400 g
Dimensions (W x L x D) in mm	210 x 100 x 60

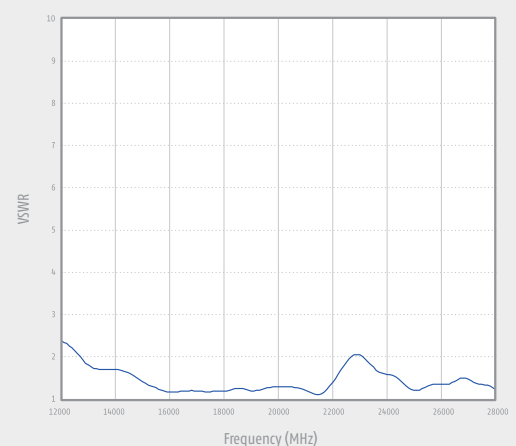
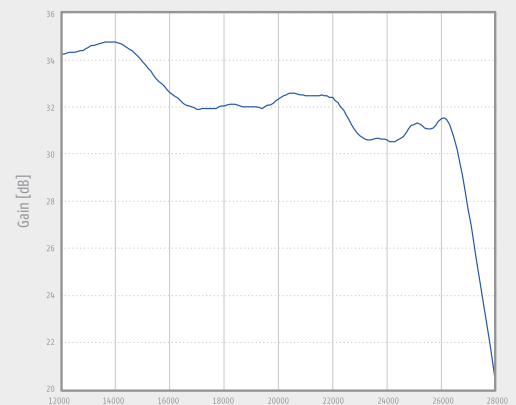

# BROADBAND PRE-AMPLIFIER – FPA-40, 18 GHZ – 40 GHZ



## Description

Low noise low power wideband amplifier for increasing sensitivity at field strength measurements and for general attenuation measurements up to 26.5 GHz. A power supply with 12 V / 300 mA DC (e.g. optional AC/DC adaptor, laboratory power supply, rechargeable battery) is required for operation. In- and output of the broadband amplifier are sensitive to electrostatic discharge.

Therefore some precaution (discharging coaxial cables and persons) is required before touching the amplifier. The amplifier input comes with SMA-female connectors. A coaxial microwave cable of 0.5 m length is supplied to connect the antenna with the amplifier. The cable is equipped with SMA-male connectors. The amplifier is equipped with a female 3/8" camera thread to be connected to a mast, e.g. to FSM-1.6. The antenna itself

is mounted with another 3/8" screw at the amplifier base. The polarization swivel can easily be achieved within seconds by a further screw in 45° steps using fixing bolts for indexing.

It is very important to avoid bending and torsion of the microwave cable, otherwise persistent damage may be a result. Therefore we recommend to mount the antenna in a way that the antenna connector points into the opposite direction as the RF-input of the amplifier. This allows a smooth routing the microwave cable with a wide bending radius.

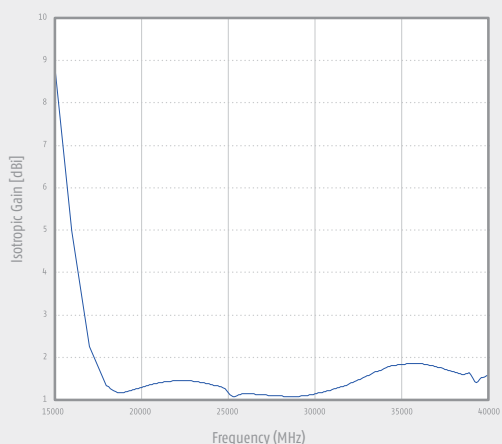
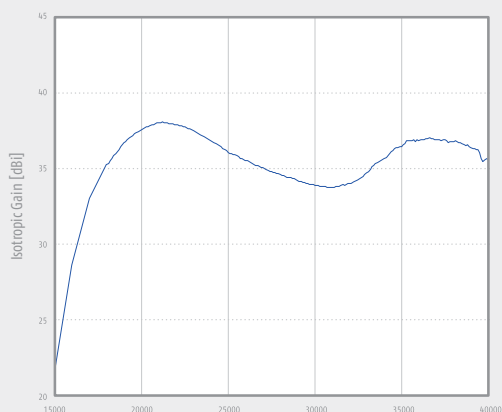

## Technical specifications

Nominal Frequency range	18 GHz - 40 GHz
Usable Frequency range	18 GHz - 40 GHz
Connectors	50 Ω 2.92
Fixation	∅ 22 mm tube
Gain	typ. 35 dB ± 4 dB
Gain min.	30 dB
Max. input power	-20 dBm (87 dBμV)
SWR typ.	< 2.6
Noise figure	5.5 dB
Power supply 1	15 V / 600 mA DC
Power supply 2	-(8 ... 15) V / -100 mA DC
Power supply via female banana sockets	4mm
Weight:	860 g
Dimensions (W x L x D) in mm	370 x 95 x 65



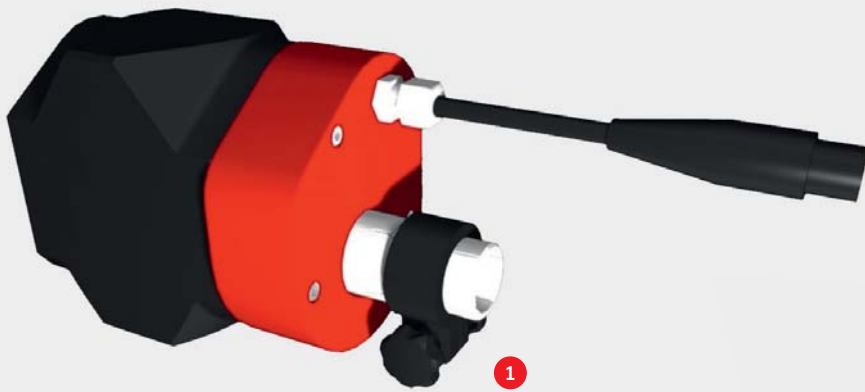

## Description

The polarization device FPD-01 **1** is designed for the polarization of antennas. The maximum weight of antennas is 5 kg, slewing range 0° – 90°. The FDP-01 polarization unit has an antenna tube of 22mm, which is equipped with a clap ring for easy and safe installation of

antennas. On the side a 3/8-16 UNC thread is foreseen for the installation of a stand. The control is effected with the controller FC06-24V. The control signal is feed through the shielded wall via an EMC filter that is mounted on the carrying unit. **2**

### Technical specifications

Polarization electric	0° – 90°
Polarization time	ca. 5 sec
Polarization accuracy	0.2°
Dimensions (W x L x D) in mm	200 x 110 x 90
Weight	2.5 kg
Antenna weight	Max. 5 kg, depending on gravity, size and used connection adapter of the antenna
Mast mount	3/8" female
Antenna tube	∅ 22mm ± 0,1mm
Voltage	24V DC
Connection	XLR male
Connection to tripod	Thread 3/8-16 UNC

### Technical data feedthrough

Dimensions (W x L x D) in mm	350 x 190 x 166
Weight	6 kg
Connection	XLR male to XLR female

# MANUAL ANTENNA MASTS FSM 1.6 / 2.0 / 4.0



## Description FSM-1.6 / FSM-2.0

The height level of the double telescopic antenna masts FSM-1.6 and FSM-2.0 can be manually adjusted from 0.9 / 1.2 m to 1.6 / 2.0 m (depending on the model). The continuous height setting is made within a few seconds. In order to avoid unwanted reflexions the mast rods are made of fibre glass. A collapsible tripod provides a secure stand and easy adaption to uneven ground. The perpendicular mast-adjustment is simplified with a spirit level mounted at the tripod. A rotatable spider fixes the tripod-legs for easy movement within seconds by one person only. Antennas can be mounted directly on the 3/8" male thread or using adapters for double stacked antennas.

### Technical specifications

Height range	0.9 - 1.6 m	1.2 - 2.0 m
Antenna or adapter mount	3/8" male	
Material mast	fibre glass	
Recommended adapters	MAS / MAD	
Weight	6 kg	7 kg
Dimensions for transport	1.0 x 0.3 x 0.3 m	1.2 x 0.3 x 0.3

## Description FSM-4.0

The main application of FSM-4.0 are emission measurements, where frequent height scans are required. Level adjustment from 0.4 m to 4.15 m can easily be done by using the manual winch. The mast can be setup and disassembled without any tools within 2 min. The FSM-4.0 tripod is suitable for both stationary and mobile applications. Thanks to its small transport dimensions it can be stored without problems even in small cars. The antennas are mounted with their 22 mm tube directly to the support, the polarization is fixed with an indexing ring for both, vertical and horizontal polarization without tools. There is no additional adapter needed to accept antennas with 22 mm tubes. Each of the three spider legs can be adjusted individually for a coarse level adjustment on uneven or inclined mounting.

### Technical specifications

Height scan	with manual winch
Height scanning range	0.4 ... 4.15 m
Required time for complete height scan	< 8 s
Required time for mast assembly	< 2 min
Antenna mount	22 mm with index ring
Mast material	fibre glass
Tripod material	zinc-plated steel
Costed option	fibre glass
Maximum antenna weight	5 kg
Total weight	13 kg
Tripod leg circuit diameter	02.06 m
Dimensions for the transport	1.17 x 0.3 x 0.3 m



## Description FAM

FRANKONIA's innovative range of positioning devices is entirely compatible with the EMC chamber environment. Using a new optical communication bus, the system provides the possibility to control up to 15 devices along a single duplex fiber optic.

Technical specifications		
Type	FAM2-4	FAM2-6
Antenna height	0.9 – 4.0 m	0.9 – 6.0 m
Max. antenna weight	12 kg at cross beam section of the mast	
Dimensions (W x L x H)	1200 x 900 x 4500 mm	1200 x 900 x 6500 mm
Weight	85 kg	92 kg
Power supply	230 V, 50/60 Hz, 4A	

Antenna types:	
• Vertical accuracy 5 mm	• Resolution 1 mm
• Polarization accuracy 0.2°	• Manual tilting + / - 5°
• 30 step adjustable vertical speed from 0.01 m/s to 0.50 m/s	• Fully automatic calculation of acceleration and deceleration ramps according to the weight of the antenna
• Mast positioning from 1.00 m to 4.00 m / 6.00 m	• Low noise, completely shielded hardware
• FRANKONIA optic communication bus	• Remote-controlled by controller type FC-02



## Description FBM 1-4

FRANKONIA's innovative range of positioning devices is entirely compatible with EMC chamber environments. In case a tilting antenna function in step-wise mode is required, the FRANKONIA boresight mast (FBM) is the right choice.

FRANKONIA's FBM offers an electrical tilt function from 0° to 50°, as well as an electrical vertical movement from 1 to 4 meters. The integrated pneumatic unit ensures the H/V polarization. Overall, the FBM offers different operating modes:

- Vertical height scan, H/V polarization, no tilt mode (normal antenna direction)
- Vertical height scan, H/V polarization, tilt mode (Boresight) (step-wise or step-less)

The antenna mast construction is compliant with CISPR 16-1-4 and ANSI C63.4. The FBM has been designed for both tilting and no tilting functionality. Various antennas can be attached with suitable adapters (not included) to the antenna mast. The FBM carries up to 8 kg antennas incl. adapter using the tilt function, and up to 12 kg antennas incl. adapter using the normal operation without tilt. A functional safety is guaranteed in case the antenna incl. adapter does not exceed the maximum weight and is balanced with counterweights (2x 3 kg weights included) during setup.

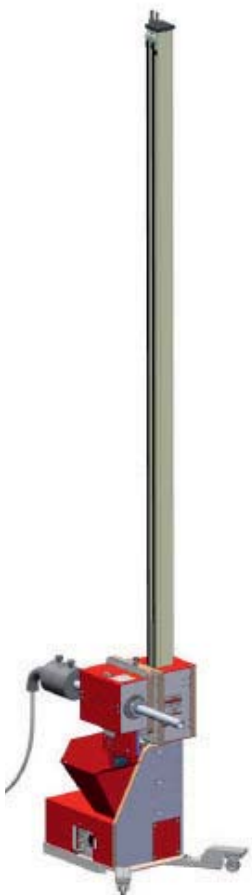

Technical specifications	
Antenna height	1.0 – 4.0 m
Load capability straighter	max. 12 kg, in balanced orientation
Load capability tilted	max. 8 kg, in balanced orientation
Height scan accuracy	± 5 mm
Height scan speed	10 mm/sec to 150 mm/sec, dynamic movement
Polarization time	approx. 5 sec
Pressure	max. 6 bar – 8 bar
Tilt accuracy	± 0,5°
Polarization accuracy	± 0,2°
Interface	IEEE 488.2 (GPIB), open standard
Dimensions (W x L x H)	1300 x 800 x 4900 mm
Weight	95 kg
Power supply	230 V, 50/60 Hz

### **Frankonia EMC Test-Systems GmbH**

Daimlerstraße 17, 91301 Forchheim, Germany

Tel.: +49 (0) 91 91 / 73 666 - 0

Fax: +49 (0) 91 91 / 73 666 - 20

Mail. [sales@frankonia-emv.com](mailto:sales@frankonia-emv.com)

### **Frankonia GmbH**

Industriestraße 16, 91180 Heideck, Germany

Tel.: +49 (0) 9177 / 98 - 500

Fax: +49 (0) 9177 / 98 - 520

Mail. [info@frankoniagroup.com](mailto:info@frankoniagroup.com)



[www.frankoniagroup.com](http://www.frankoniagroup.com)



**FRANKONIA**